

10°

Katalog dílů

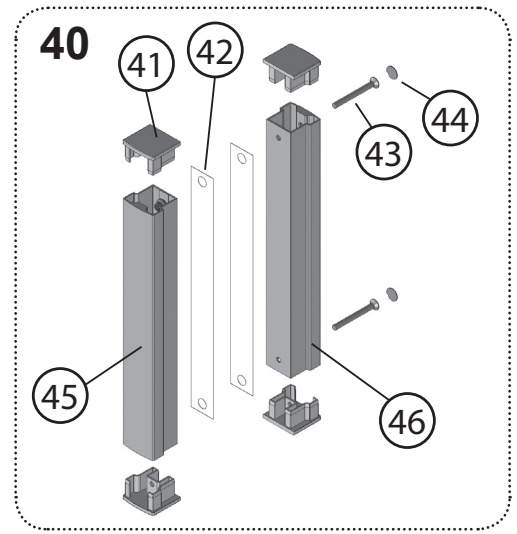

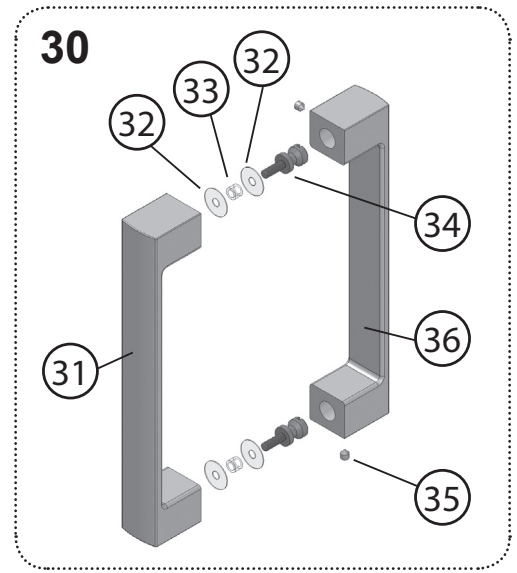

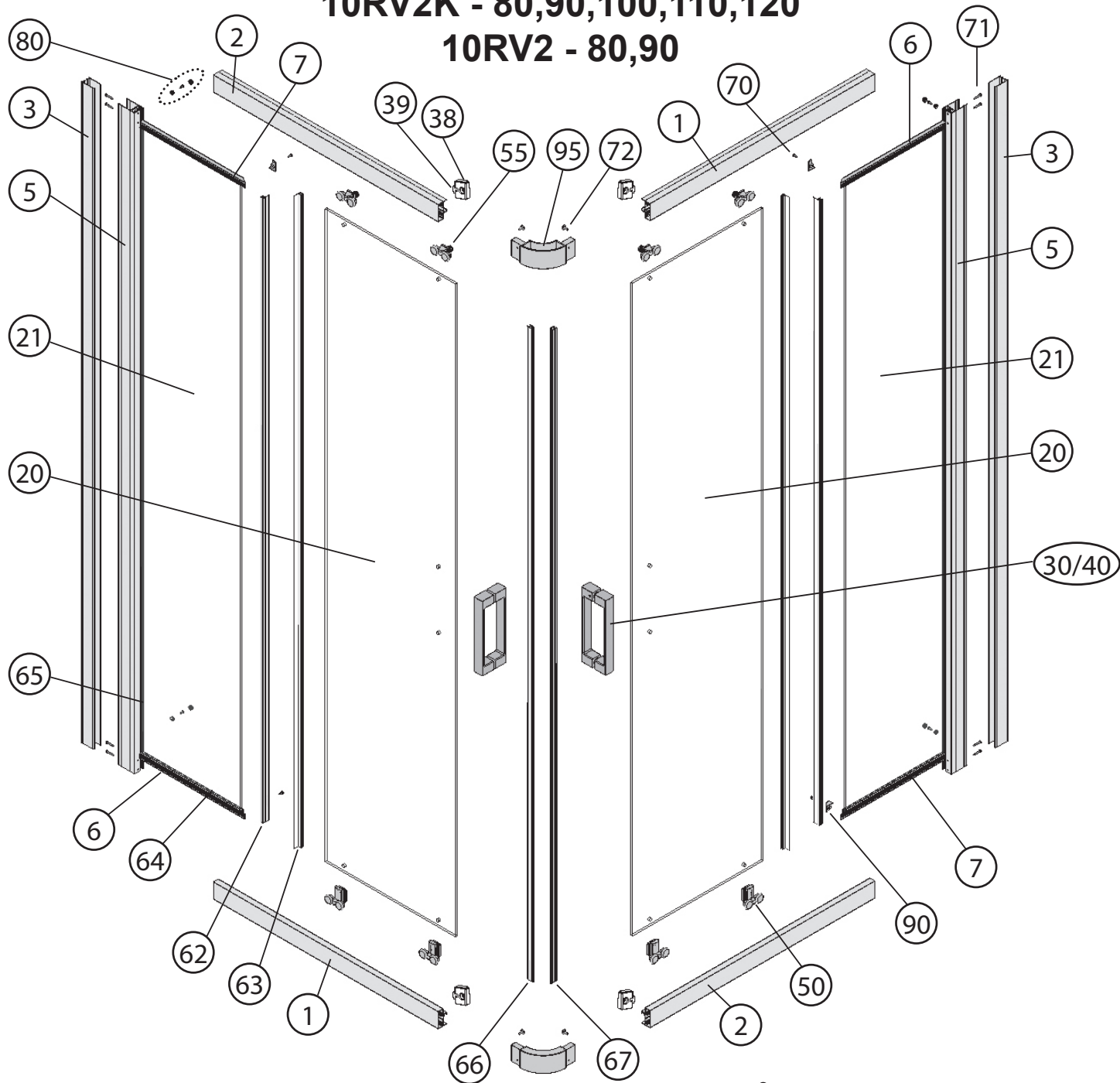



Platnost od 01/2014

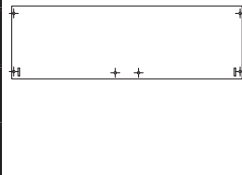







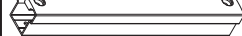

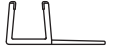
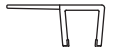

RAVAK[®]

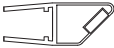
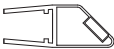
10RV2K - 80,90,100,110,120
10RV2 - 80,90







10RV2K - 80,90,100,110,120 10RV2 - 80,90							
Číslo dílu:	Název:	Množství [ks]:	Rozměr [mm]:	SIČ bílá:	SIČ satin:	SIČ bright:	Obrázek:
1	Vodící profil 10° - DSRV2-80 LR15232/04L	2	646mm - RV2_80	XVF23204L10646	XVF23204LX0646	XVF23204LU0646	
1	Vodící profil 10° - DSRV2-90 LR15232/05L	2	746mm - RV2_90	XVF23205L10746	XVF23205LX0746	XVF23205LU0746	
1	Vodící profil 10° - DSRV2-100 LR15232/06L	2	846mm - RV2_100	XVF23206L10846	XVF23206LX0846	XVF23206LU0846	
1	Vodící profil 10° - DSRV2-110 LR15232/07L	2	946mm - RV2_110	XVF23207L10946	XVF23207LX0946	XVF23207LU0946	
1	Vodící profil 10° - DSRV2-120 LR15232/08L	2	1046mm - RV2_120	XVF23208L11046	XVF23208LX1046	XVF23208LU1046	
2	Vodící profil 10° - DSRV2-80 LR15232/04P	2	646mm - RV2_80	XVF23204P10646	XVF23204PX0646	XVF23204PU0646	
2	Vodící profil 10° - DSRV2-90 LR15232/05P	2	746mm - RV2_90	XVF23205P10746	XVF23205PX0746	XVF23205PU0746	
2	Vodící profil 10° - DSRV2-100 LR15232/06P	2	846mm - RV2_100	XVF23206P10846	XVF23206PX0846	XVF23206PU0846	
2	Vodící profil 10° - DSRV2-110 LR15232/07P	2	946mm - RV2_110	XVF23207P10946	XVF2320PLX0946	XVF23207PU0946	
2	Vodící profil 10° - DSRV2-120 LR15232/08P	2	1046mm - RV2_120	XVF23208P11046	XVF2320PLX1046	XVF23208PU1046	
3	Ustavovací profil 9979.01	2	1900	XV99790111900	XV997901X1900	XV997901U1900	
5	Svislý profil 10° LR15225/01	2	1900	XVF2250111900	XVF22501X1900	XVF22501U1900	
6	Lem skla 10° - DSRV2-80 11908/07	2	297mm - RV2_80	XVRA098710297	XVRA0987X0297	XVRA0987U0297	
6	Lem skla 10° - DSRV2-90 11908/09	2	347mm - RV2_90	XVRA098910347	XVRA0989X0347	XVRA0989U0347	
6	Lem skla 10° - DSRV2-100 11908/11	2	397mm - RV2_100	XVRA099110397	XVRA0991X0397	XVRA0991U0397	
6	Lem skla 10° - DSRV2-110 11908/13	2	447mm - RV2_110	XVRA099310447	XVRA0993X0447	XVRA0993U0447	
6	Lem skla 10° - DSRV2-120 11908/15	2	497mm - RV2_120	XVRA099510497	XVRA0995X0497	XVRA0995U0497	
7	Lem skla 10° - DSRV2-80 11908/08	2	297mm - RV2_80	XVRA098810297	XVRA0988X0297	XVRA0988U0297	
7	Lem skla 10° - DSRV2-90 11908/10	2	347mm - RV2_90	XVRA099010347	XVRA0990X0347	XVRA0990U0347	
7	Lem skla 10° - DSRV2-100 11908/12	2	397mm - RV2_100	XVRA099210397	XVRA0992X0397	XVRA0992U0397	
7	Lem skla 10° - DSRV2-110 11908/14	2	447mm - RV2_110	XVRA099410447	XVRA0994X0447	XVRA0994U0447	

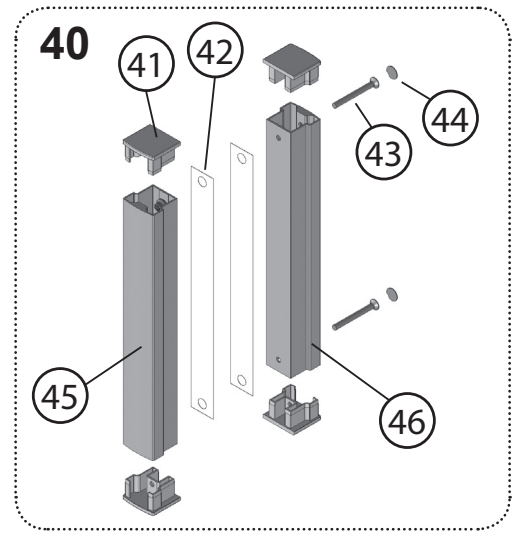
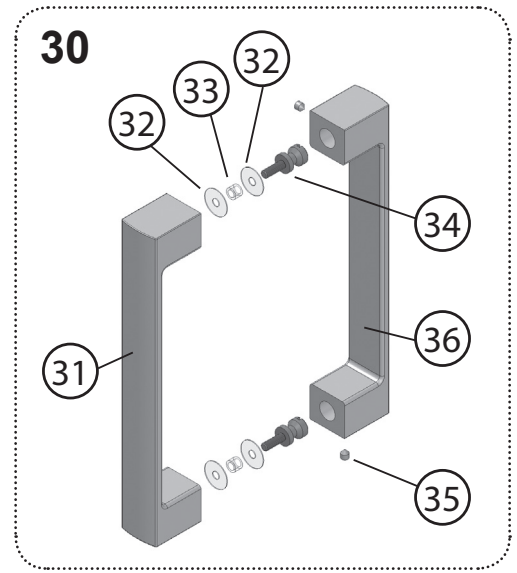
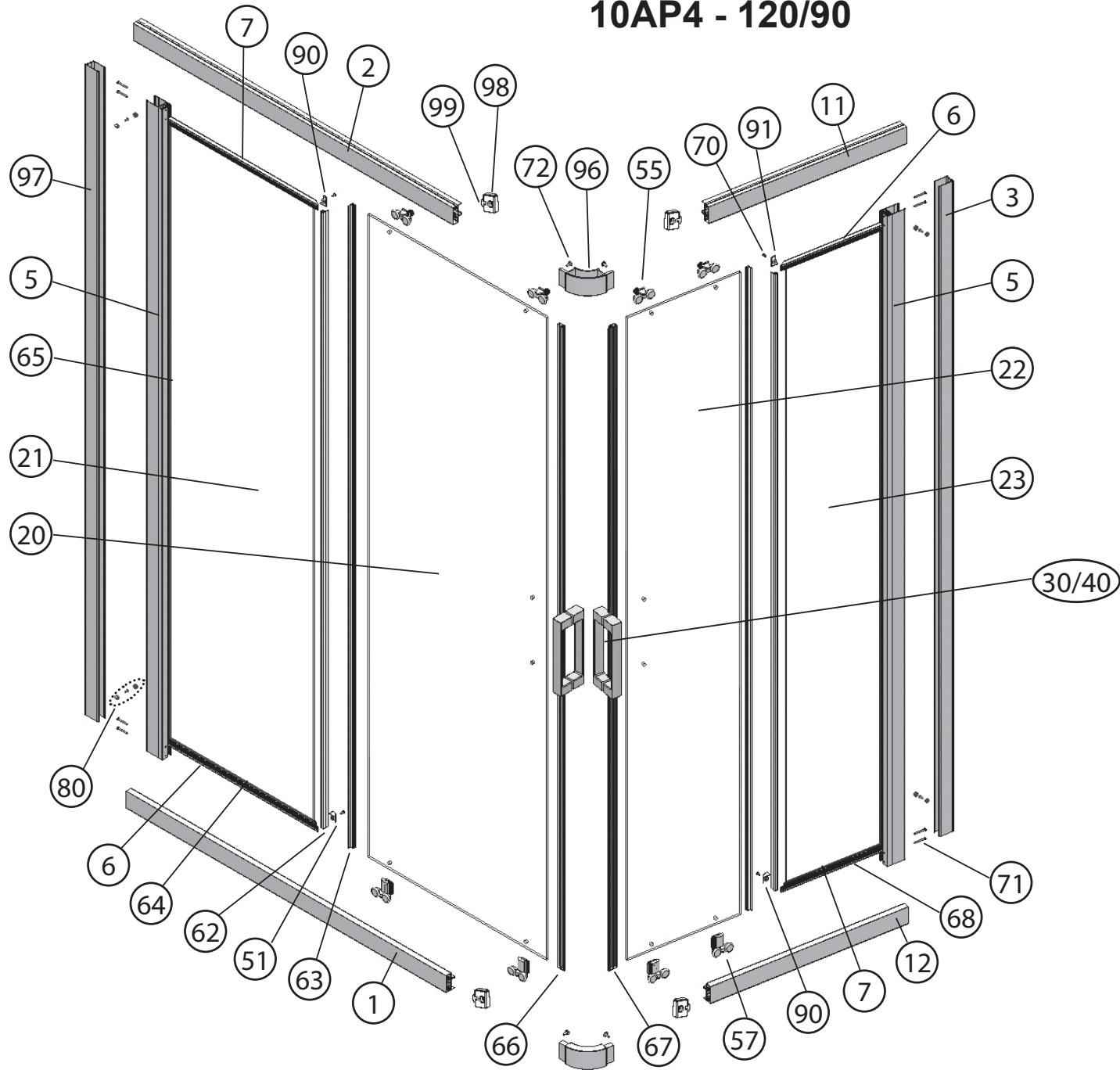

7	Lem skla 10° - DSRV2-120 11908/16	2	497mm - RV2_120	XVRA099610497	XVRA0996X0497	XVRA0996U0497	
20	Sklo 6,0x1879x383 10° čiré DS-SR-DV-005	2	1879x383mm - RV2_80	X4Z160I793830			
20	Sklo 6,0x1879x433 10° čiré DS-SR-DV-006	2	1879x433mm - RV2_90	X4Z160I794330			
20	Sklo 6,0x1879x483 10° čiré DS-SR-DV-007	2	1879x483mm - RV2_100	X4Z160I794830			
20	Sklo 6,0x1879x533 10° čiré DS-SR-DV-008	2	1879x533mm - RV2_110	X4Z160I795330			
20	Sklo 6,0x1879x583 10° čiré DS-SR-DV-009	2	1879x583mm - RV2_120	X4Z160I795830			
21	Sklo 6,0x1824x291 10° čiré DS-SR-PS-005	2	1824x291mm - RV2_80	X4Z160I242910			
21	Sklo 6,0x1824x341 10° čiré DS-SR-PS-006	2	1824x341mm - RV2_90	X4Z160I243410			
21	Sklo 6,0x1824x391 10° čiré DS-SR-PS-007	2	1824x391mm - RV2_100	X4Z160I243910			
21	Sklo 6,0x1824x441 10° čiré DS-SR-PS-008	2	1824x441mm - RV2_110	X4Z160I244410			
21	Sklo 6,0x1824x491 10° čiré DS-SR-PS-009	2	1824x491mm - RV2_120	X4Z160I244910			
31	Madlo 10° vnější DS-ZA-004 zamak/chrom	2	315x37,7x28	X8DSZA004000A			
32	Podložka madla	8	Ø20x1	X3MA0100200			
33	Bužírka transparent prům. 5/7,5-5	4	Ø7,5x5	X80001075050			
34	Šroub madla	4	Ø12x30° M5	X3SM1800300			
35	Šroub M5x 6 DIN 914 stavěcí nerez	4	M5x6	X90914050060			
36	Madlo 10° vnitřní DS-ZA-003 zamak/chrom	2	315x38x28	X8DSZA003000A			
41	Krytka madla 10° Chrom	8	30,4x28,2x17	X3DSPL001A			
42	Podložka madla 10° AL Nosal transparent	4	203x22	X3DSPDL001			
43	Šroub M4x55 DIN 966 nerez A2	4	M4x55	X90966040550			
44	Madlo 10° vnější DS-AL-008-001	2	209x30x28	X3DSAL008001A			
45	Madlo 10° vnitřní DS-AL-008-002	2	209x30x28	X3DSAL008002A			

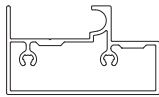

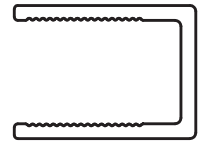
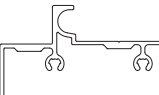

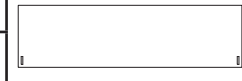

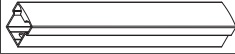

50	QL1120 Kolečko dveří Blix	4		X3BLQL112000	
55	HS-067 Kolečko Blix spodní	4		X3BLHS067000	
62	Těsncí lišta Blix-10° dl.1900mm	2	1800	X8BLPL150050	
63	Těsncí lišta Blix-10° dl.1900mm	2	1879	X8BLPL150050	
64	Zasklívací profil 111 CB H 2652 Transparent	4	278/328/378/428/478	X8B100000000	
65	Zasklívací profil 90 CB H 2586 Transparent	2	1830	X89000000000	
66	Magnet ILPEA C1247 dl.1879 mm	1	1879	X6C124700220	
67	Magnet ILPEA C1248 dl.1879 mm	1	1879	X6C124800220	
70	Šroub samořez 3,5x13 DIN 7981 A2 nerez	4	Ø3,5x13	X97981035130	
71	Šroub samořez 3,5x38 DIN 7981 A2 nerez	8	Ø3,5x38	X97981035380	
72	Šroub M4x12 DIN 912 A2 nerez	4	M4x12	X90912040120	
81	Podložka krytky šroubu	4	Ø10x4,5	X8BLPL157000	
82	Krytka šroubu Chrom	4	Ø11,4x5,1	X8BLPL15600A	
83	Šroub samořez 3,5x13 DIN 7981 A2 nerez	4	Ø3,5x13	X97981035130	
90	Koncovka 84A Chrom	2		X884A000000A	
91	Koncovka 84B Chrome	2		X884B000000A	
95	Spojovací díl koutu 10°/90° DS-ZA-002	2		X8DSZA002000A	
98	Doraz - hlavní díl Chrom	4		X8BLPL13500A	
99	Doraz - vložka	4		X8BLPL136000	

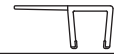
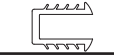
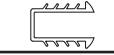
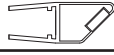
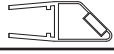
10AP4 - 120/90







10AP4 - 120/90							
Číslo dílu:	Název:	Množství [ks]:	Rozměr [mm]:	SIČ bílá:	SIČ satin:	SIČ bright:	Obrázek:
1	Vodící profil 10°- DS10°-120/120 LR15232/18L	1	1077mm - AP4_120	XVF23218L11077	XVF23218LX1077	XVF23218LU1077	
2	Vodící profil 10°- DS10°-120/120 LR15232/18P	1	1077mm - AP4_120	XVF23218P11077	XVF23218PX1077	XVF23218PU1077	
3	Ustavovací profil 9979.01	1	1900	XV99790111900	XV997901X1900	XV997901U1900	
5	Svislý profil 10° LR15225/01	2	1900	XVF2250111900	XVF22501X1900	XVF22501U1900	
6	Lem skla 10° - DS10°-120/120 11908/37	1	512mm - AP4_120	XVRA0911710512	XVRA09117X0512	XVRA09117U0512	
6	Lem skla 10° - DS10°-120/70 11908/35	1	250mm - AP4_70	XVRA0911510250	XVRA09115X0250	XVRA09115U0250	
7	Lem skla 10° - DS10° 120/120 11908/38	1	512mm - AP4_120	XVRA0911810512	XVRA09118X0512	XVRA09118U0512	
7	Lem skla 10° - DS10°-120/70 11908/36	1	250mm - AP4_70	XVRA0911610250	XVRA09116X0250	XVRA09116U0250	
9	Ust.profil šikmý 10° LR15282/01	1	1900	XVF2820111900	XVF28201X1900	XVF28201U1900	
11	Vodící profil 10°- DS10°-120/70 LR15232/19L	1	549mm - AP4_70	XVF23219L10549	XVF23219LX0549	XVF23219LU0549	
12	Vodící profil 10°- DS10°-120/70 LR15232/19P	1	549mm - AP4_70	XVF23219P10549	XVF23219PX0549	XVF23219PU0549	
20	Sklo 6,0x1879x594 10° čiré DS-SR-DV-019	1	1879x594mm - AP4_120		X4Z160I795940		
21	Sklo 6,0x1824x506 10° čiré DS-SR-PS-019	1	1824x506mm - AP4_120		X4Z160I245060		
22	Sklo 6,0x1879x331 10° čiré DS-SR-DV-020	1	1879x331mm - AP4_70		X4Z160I793310		
23	Sklo 6,0x1824x244 10° čiré DS-SR-PS-020	1	1879x244mm - AP4_70		X4Z160I242440		

31	Madlo 10° vnější DS-ZA-004 zamak/chrom	2	315x37,7x28	X8DSZA004000A		
32	Podložka madla	8	Ø20x1	X3MA0100200		
33	Bužírka transparent prům. 5/7,5-5	4	Ø7,5x5	X80001075050		
34	Šroub madla	4	Ø12x30° M5	X3SM1800300		
35	Šroub M5x 6 DIN 914 stavěcí nerez	4	M5x6	X90914050060		
36	Madlo 10° vnitřní DS-ZA-003 zamak/chrom	2	315x38x28	X8DSZA003000A		
41	Krytka madla 10° Chrom	8	30,4x28,2x17	X3DSPL001A		
42	Podložka madla 10° AL Nosal transparent	4	203x22	X3DSPDL001		
43	Šroub M4x55 DIN 966 nerez A2	4	M4x55	X90966040550		
44	Madlo 10° vnější DS-AL-008-001	2	209x30x28	X3DSAL008001A		
45	Madlo 10° vnitřní DS-AL-008-002	2	209x30x28	X3DSAL008002A		
50	QL1120 Kolečko dveří Blix	4		X3BLQL112000		
55	HS-067 Kolečko Blix spodní	4		X3BLHS067000		

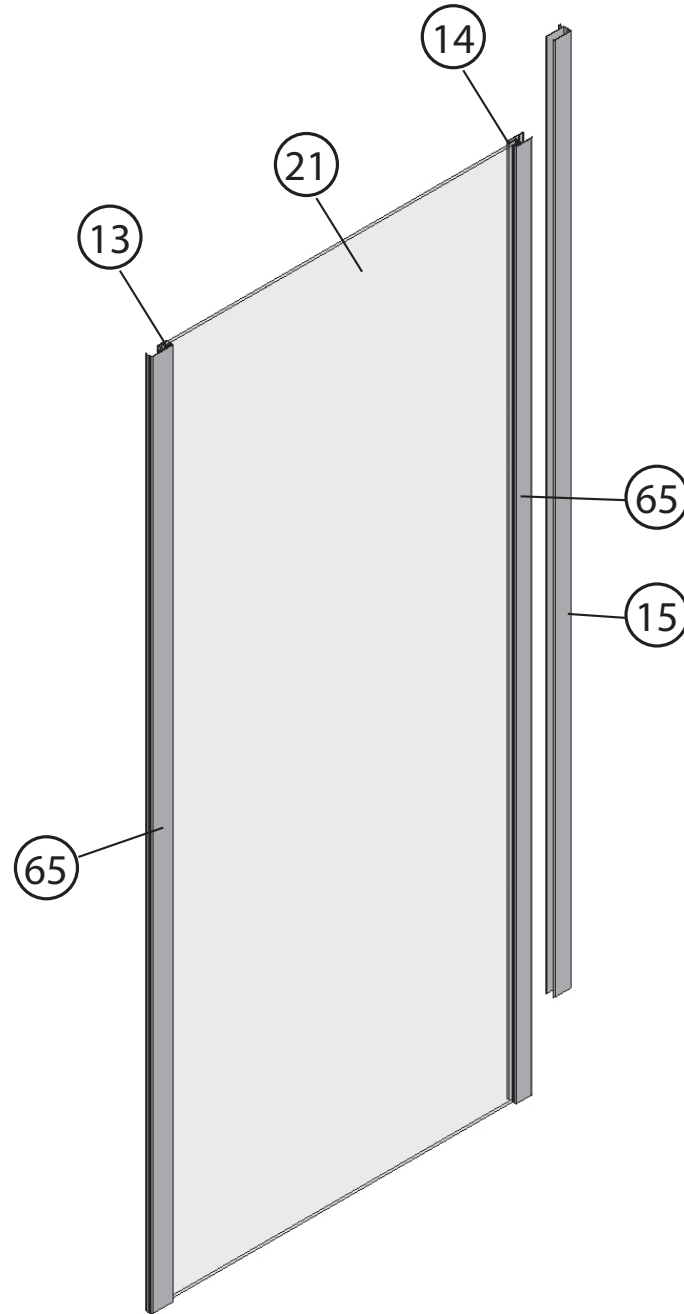
62	Těsncí lišta Blix-10° dl.1900mm	2	1800		X8BLPL150050	
63	Těsncí lišta Blix-10° dl.1900mm	2	1879		X8BLPL150050	
64	Zasklívací profil 111 CB H 2652 Transparent	4	278/328/378/428/478		X8B100000000	
65	Zasklívací profil 90 CB H 2586 Transparent	2	1830		X89000000000	
66	Magnet ILPEA C1247 dl.1879 mm	1	1879		X6C124700220	
67	Magnet ILPEA C1248 dl.1879 mm	1	1879		X6C124800220	
70	Šroub samořez 3,5x13 DIN 7981 A2 nerez	4	Ø3,5x13		X97981035130	
71	Šroub samořez 3,5x38 DIN 7981 A2 nerez	8	Ø3,5x38		X97981035380	
72	Šroub M4x12 DIN 912 A2 nerez	4	M4x12		X90912040120	
81	Podložka krytky šroubu	4	Ø10x4,5		X8BLPL157000	
82	Krytka šroubu Chrom	4	Ø11,4x5,1		X8BLPL15600A	
83	Šroub samořez 3,5x13 DIN 7981 A2 nerez	4	Ø3,5x13		X97981035130	
90	Koncovka 84A Chrom	2			X884A000000A	
91	Koncovka 84B Chrome	2			X884B000000A	
95	Spojovací díl koutu 10°/90° DS-ZA-002	2			X8DSZA002000A	
98	Doraz - hlavní díl Chrom	4			X8BLPL13500A	
99	Doraz - vložka	4			X8BLPL136000	

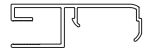
10PS – 80, 90, 100



10PS – 80, 90, 100							
Číslo dílu:	Název:	Množství [ks]:	Rozměr [mm]:	SIČ bílá:	SIČ satin:	SIČ bright:	Obrázek:
13	Svislý profil rohový 10° LR15224/01	1	1900	XVF2240111900	XVF22401X1900	XVF22401U1900	
14	Svislý profil zed/PS 10° LR15242/01	1	1900	XVF2420111900	XVF24201X1900	XVF24201U1900	
15	Ust.profil Pivot 12216/01	1	1900	XVC2160111900	XVC21601X1900	XVC21601U1900	
21	Sklo 6,0x1900x709 10° čiré DS-SR-PS-021	1	1900x709mm - PS80	X4Z160J007090			
21	Sklo 6,0x1900x809 10° čiré DS-SR-PS-022	1	1900x809mm - PS90	X4Z160J008090			
21	Sklo 6,0x1900x909 10° čiré DS-SR-PS-023	1	1900x909mm - P100	X4Z160J009090			
65	Zasklívací profil 90 CB H 2586 Transparent	1	1900	X89000000000			

10DP2 – 100, 110, 120

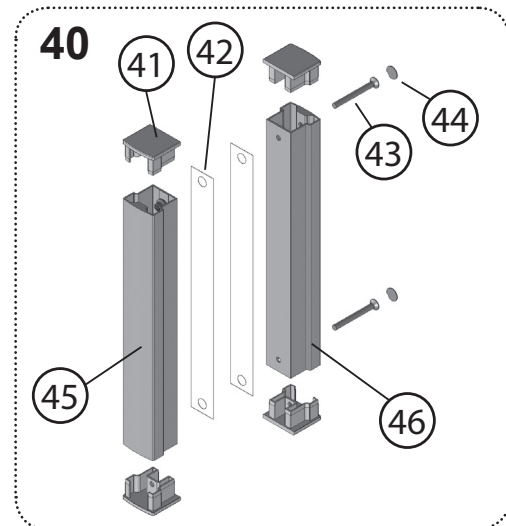
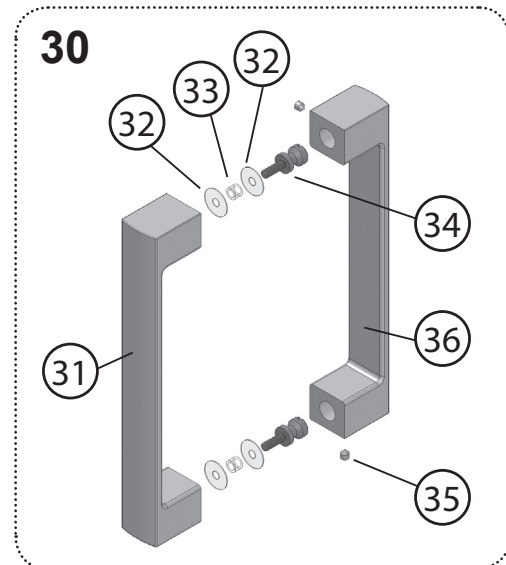
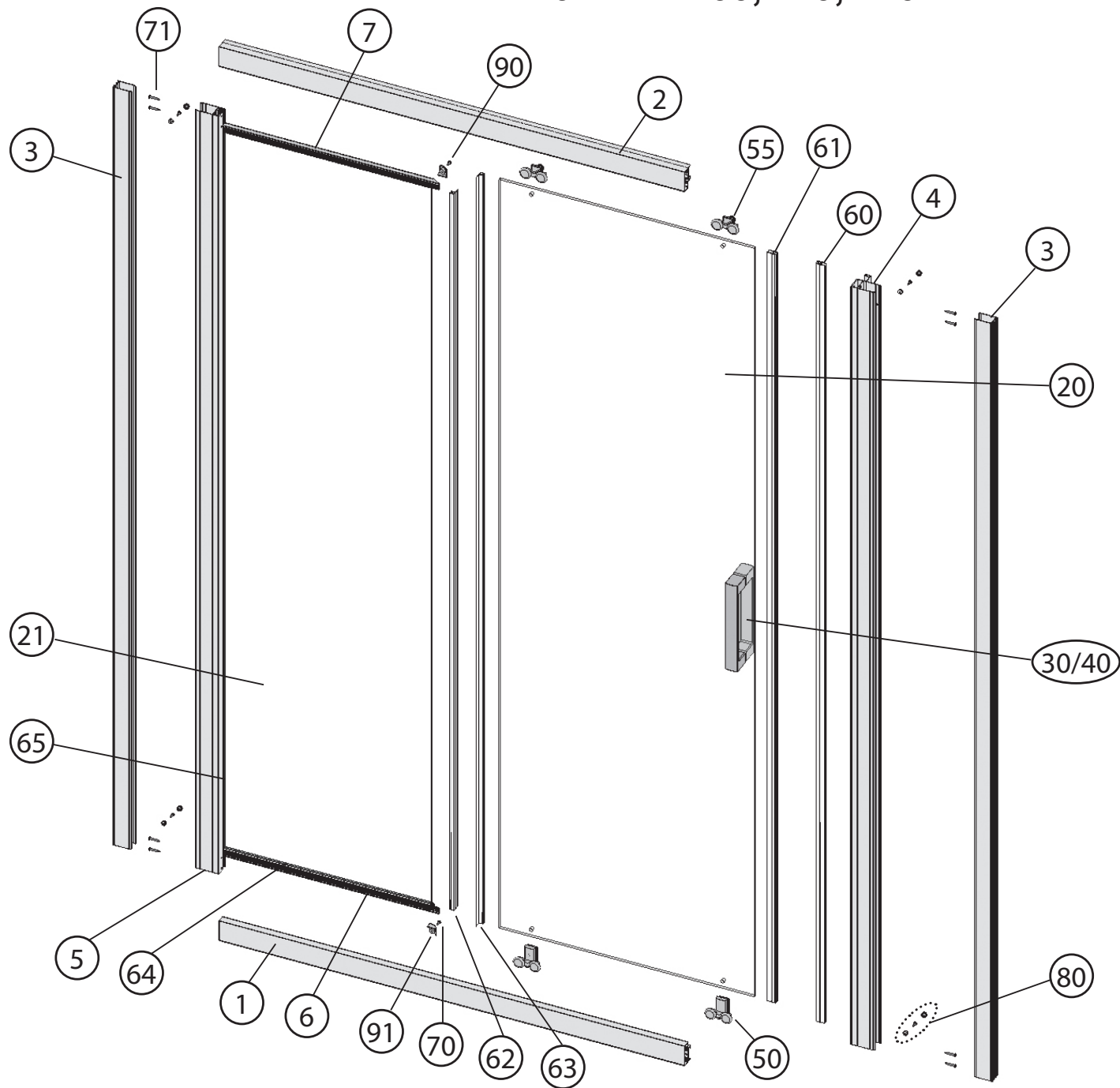





10DP2 – 100, 110, 120							
Číslo dílu:	Název:	Množství [ks]:	Rozměr [mm]:	SIČ bílá:	SIČ satin:	SIČ bright:	Obrázek:
1	Vodící profil 10° - DSDP2-100 LR15232/01L	1	864mm - DP2_100	XVF23201L10864	XVF23201LX0864	XVF23201LU0864	
1	Vodící profil 10° - DSDP2-100 LR15232/02L	1	964mm - DP2_110	XVF23202L10964	XVF23202LX0964	XVF23202LU0964	
1	Vodící profil 10° - DSDP2-100 LR15232/03L	1	1064mm - DP2_120	XVF23203L11064	XVF23203LX1064	XVF23203LU1064	
2	Vodící profil 10° - DSDP2-100 LR15232/01P	1	864mm - DP2_100	XVF23201P10864	XVF23201PX0864	XVF23201PU0864	
2	Vodící profil 10° - DSDP2-100 LR15232/02P	1	964mm - DP2_110	XVF23202P10964	XVF23202PX0964	XVF23202PU0964	
2	Vodící profil 10° - DSDP2-100 LR15232/03P	1	1064mm - DP2_120	XVF23203P11064	XVF23203PX1064	XVF23203PU1064	
3	Ustavovací profil 9979.01	2	1900	XV99790111900	XV997901X1900	XV997901U1900	
4	Svislý magn. profil 10° LR15226/02	1	1900	XVF2260211900	XVF22602X1900	XVF22602U1900	
5	Svislý profil 10° LR15225/01	1	1900	XVF2250111900	XVF22501X1900	XVF22501U1900	
6	Lem skla 10° - DSDP2-110 11908/01	1	387mm - DP2_100	XVRA098110387	XVRA0981X0387	XVRA0981U0387	
6	Lem skla 10° - DSDP2-110 11908/03	1	437mm - DP2_110	XVRA098310437	XVRA0983X0437	XVRA0983U0437	
6	Lem skla 10° - DSDP2-110 11908/05	1	487mm - DP2_120	XVRA098510487	XVRA0985X0487	XVRA0985U0487	
7	Lem skla 10° - DSDP2-110 11908/02	1	387mm - DP2_100	XVRA098210387	XVRA0982X0387	XVRA0982U0387	
7	Lem skla 10° - DSDP2-110 11908/02	1	437mm - DP2_110	XVRA098410437	XVRA0984X0437	XVRA0984U0437	
7	Lem skla 10° - DSDP2-110 11908/06	1	487mm - DP2_120	XVRA098610487	XVRA0986X0487	XVRA0986U0487	
20	Sklo 6,0x1879x488 10° čiré DS-SR-DV-002	1	1879x488mm - DP2_100	X4Z160I794880			
20	Sklo 6,0x1879x538 10° čiré DS-SR-DV-003	1	1879x538mm - DP2_110	X4Z160I795380			
20	Sklo 6,0x1879x588 10° čiré DS-SR-DV-004	1	1879x588mm - DP2_120	X4Z160I795880			

21	Sklo 6,0x1824x381 10° čiré DS-SR-PS-002	1	1824x381mm - DP2_100	X4Z160I243810	
21	Sklo 6,0x1824x431 10° čiré DS-SR-PS-003	1	1824x431mm - DP2_110	X4Z160I244310	
21	Sklo 6,0x1824x481 10° čiré DS-SR-PS-004	1	1824x481mm - DP2_120	X4Z160I244810	
31	Madlo 10° vnější DS-ZA-004 zamak/chrom	1	315x37,7x28	X8DSZA004000A	
32	Podložka madla	4	Ø20x1	X3MA0100200	
33	Bužírka transparent prům. 5/7,5-5	2	Ø7,5x5	X80001075050	
34	Šroub madla	2	Ø12x30° M5	X3SM1800300	
35	Šroub M5x 6 DIN 914 stavěcí nerez	2	M5x6	X90914050060	
36	Madlo 10° vnitřní DS-ZA-003 zamak/chrom	1	315x38x28	X8DSZA003000A	
41	Krytka madla 10° Chrom	4	30,4x28,2x17	X3DSPL001A	
42	Podložka madla 10° AL Nosal transparent	2	203x22	X3DSPDL001	
43	Šroub M4x55 DIN 966 nerez A2	2	M4x55	X90966040550	
44	Madlo 10° vnější DS-AL-008-001	1	209x30x28	X3DSAL008001A	
45	Madlo 10° vnitřní DS-AL-008-002	1	209x30x28	X3DSAL008002A	
50	QL1120 Kolečko dveří Blix	2		X3BLQL112000	
55	HS-067 Kolečko Blix spodní	2		X3BLHS067000	
60	Magnet ILPEA C1246 dl.1900 mm	1	1900	X6C124600160	
61	Magnet ILPEA C1246 dl.1879 mm	1	1879	X6C124600220	
62	Těsnící lišta Blix-10° dl.1900mm	1	1800	X8BLPL150050	

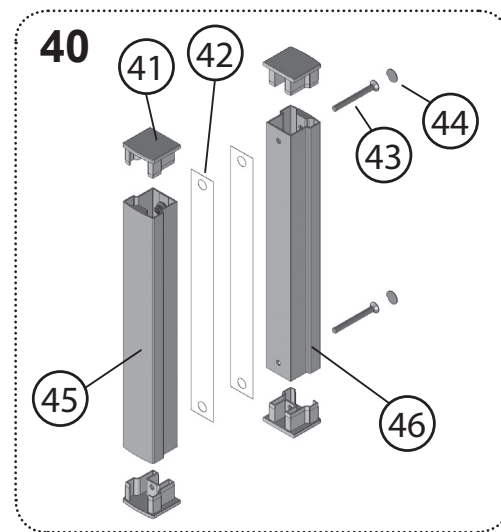
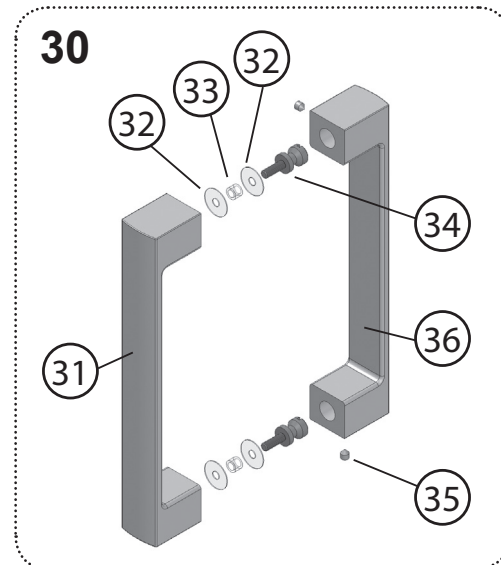
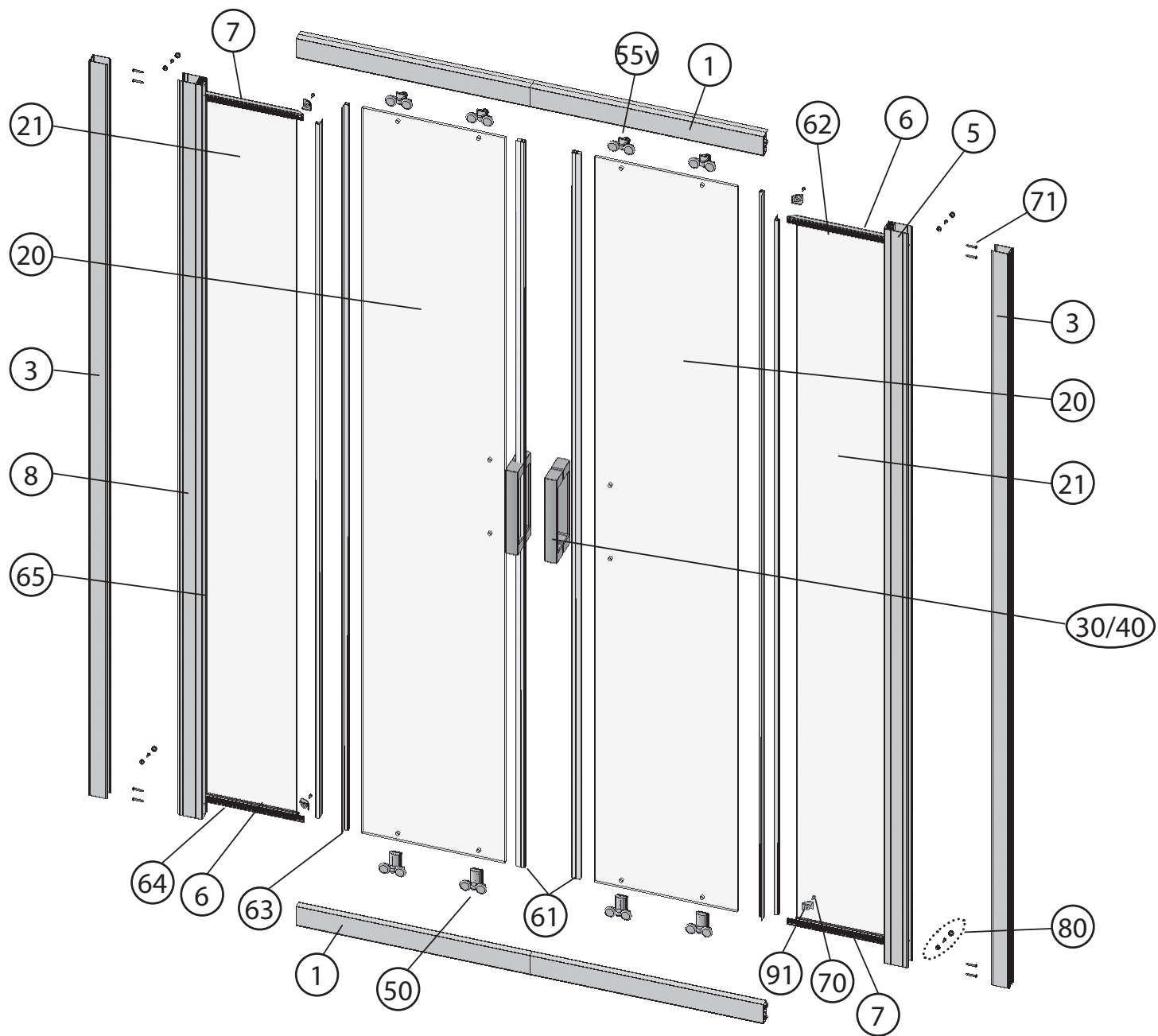









63	Těsncí lišta Blix-10° dl.1900mm	1	1879	X8BLPL150050	
64	Zasklívací profil 111 CB H 2652 Transparent	2	368/418/468	X8B100000000	
65	Zasklívací profil 90 CB H 2586 Transparent	1	1830	X890000000000	
70	Šroub samořez 3,5x13 DIN 7981 A2 nerez	2	Ø3,5x13	X97981035130	
71	Šroub samořez 3,5x38 DIN 7981 A2 nerez	8	Ø3,5x38	X97981035380	
81	Podložka krytky šroubu	4	Ø10x4,5	X8BLPL157000	
82	Krytka šroubu Chrom	4	Ø11,4x5,1	X8BLPL15600A	
83	Šroub samořez 3,5x13 DIN 7981 A2 nerez	4	Ø3,5x13	X97981035130	
90	Koncovka 84A Chrom	1		X884A000000A	
91	Koncovka 84B Chrome	1		X884B000000A	

10DP4 – 120, 130, 140, 150, 160, 170, 180, 190, 200

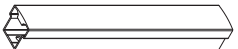

10DP4-120-200							
Číslo dílu:	Název:	Množství [ks]:	Rozměr [mm]:	SIČ bílá:	SIČ satin:	SIČ bright:	Obrázek:
1	Vodící profil 10° - DSDP4-120 LR15232/09	2	1062mm - DP4_120	XVF2320911062	XVF23209X1062	XVF23209U1062	
1	Vodící profil 10° - DSDP4-130 LR15232/10	2	1162mm - DP4_130	XVF2321011162	XVF23210X1162	XVF23210U1162	
1	Vodící profil 10° - DSDP4-140 LR15232/11	2	1262mm - DP4_140	XVF2321111262	XVF23211X1262	XVF23211U1262	
1	Vodící profil 10° - DSDP4-150 LR15232/12	2	1362mm - DP4_150	XVF2321211362	XVF23212X1362	XVF23212U1362	
1	Vodící profil 10° - DSDP4-160 LR15232/13	2	1462mm - DP4_160	XVF2321311462	XVF23213X1462	XVF23213U1462	
1	Vodící profil 10° - DSDP4-170 LR15232/14	2	1562mm - DP4_170	XVF2321411562	XVF23214X1562	XVF23214U1562	
1	Vodící profil 10° - DSDP4-180 LR15232/15	2	1662mm - DP4_180	XVF2321511662	XVF23215X1662	XVF23215U1662	
1	Vodící profil 10° - DSDP4-190 LR15232/16	2	1762mm - DP4_190	XVF2321611762	XVF23216X1762	XVF23216U1762	
1	Vodící profil 10° - DSDP4-200 LR15232/17	2	1862mm - DP4_200	XVF2321711862	XVF23217X1862	XVF23217U1862	
3	Ustavovací profil 9979.01	2	1900	XV99790111900	XV997901X1900	XV997901U1900	
5	Svislý profil 10° LR15225/01	1	1900	XVF2250111900	XVF22501X1900	XVF22501U1900	
6	Lem skla 10° - DSDP4-120 11908/17	2	221mm - DP4_120	XVRA099710221	XVRA0997X0221	XVRA0997U0221	
6	Lem skla 10° - DSDP4-130 11908/19	2	246mm - DP4_130	XVRA099910246	XVRA0999X0246	XVRA0999U0246	
6	Lem skla 10° - DSDP4-140 11908/21	2	271mm - DP4_140	XVRA0910110271	XVRA09101X0271	XVRA09101U0271	
6	Lem skla 10° - DSDP4-150 11908/23	2	296mm - DP4_150	XVRA0910310296	XVRA09103X0296	XVRA09103U0296	
6	Lem skla 10° - DSDP4-160 11908/25	2	321mm - DP4_160	XVRA0910510321	XVRA09105X0321	XVRA09105U0321	
6	Lem skla 10° - DSDP4-170 11908/27	2	346mm - DP4_170	XVRA0910710346	XVRA09107X0346	XVRA09107U0346	
6	Lem skla 10° - DSDP4-180 11908/29	2	371mm - DP4_180	XVRA0910910371	XVRA09109X0371	XVRA09109U0371	
6	Lem skla 10° - DSDP4-190 11908/31	2	396mm - DP4_190	XVRA0911110396	XVRA09111X0396	XVRA09111U0396	
6	Lem skla 10° - DSDP4-200 11908/33	2	421mm - DP4_200	XVRA0911310421	XVRA09113X0421	XVRA09113U0421	

7	Lem skla 10° - DSDP4-120 11908/18	2	221mm - DP4_120	XVRA099810221	XVRA0998X0221	XVRA0998U0221	
7	Lem skla 10° - DSDP4-130 11908/20	2	246mm - DP4_130	XVRA0910010246	XVRA09100X0246	XVRA09100U0246	
7	Lem skla 10° - DSDP4-140 11908/22	2	271mm - DP4_140	XVRA0910210271	XVRA09102X0271	XVRA09102U0271	
7	Lem skla 10° - DSDP4-150 11908/24	2	296mm - DP4_150	XVRA0910410296	XVRA09104X0296	XVRA09104U0296	
7	Lem skla 10° - DSDP4-160 11908/26	2	321mm - DP4_160	XVRA0910610321	XVRA09106X0321	XVRA09106U0321	
7	Lem skla 10° - DSDP4-170 11908/28	2	346mm - DP4_170	XVRA0910810346	XVRA09108X0346	XVRA09108U0346	
7	Lem skla 10° - DSDP4-180 11908/30	2	371mm - DP4_180	XVRA0911010371	XVRA09110X0371	XVRA09110U0371	
7	Lem skla 10° - DSDP4-190 11908/32	2	396mm - DP4_190	XVRA0911210396	XVRA09112X0396	XVRA09112U0396	
7	Lem skla 10° - DSDP4-200 11908/34	2	421mm - DP4_200	XVRA0911410421	XVRA09114X0421	XVRA09114U0421	
8	Svislý profil 10° LR15225/02 s ovory	1	1900	XVF2250211900	XVF22502X1900	XVF22502U1900	
20	Sklo 6,0x1879x322 10° čiré DS-SR-DV-010	2	1879x322mm - DP4_120	X4Z1601793220			
20	Sklo 6,0x1879x347 10° čiré DS-SR-DV-011	2	1879x347mm - DP4_130	X4Z1601793470			
20	Sklo 6,0x1879x372 10° čiré DS-SR-DV-012	2	1879x372mm - DP4_140	X4Z1601793720			
20	Sklo 6,0x1879x397 10° čiré DS-SR-DV-013	2	1879x397mm - DP4_150	X4Z1601793970			
20	Sklo 6,0x1879x422 10° čiré DS-SR-DV-014	2	1879x422mm - DP4_160	X4Z1601794220			
20	Sklo 6,0x1879x447 10° čiré DS-SR-DV-015	2	1879x447mm - DP4_170	X4Z1601794470			
20	Sklo 6,0x1879x472 10° čiré DS-SR-DV-016	2	1879x472mm - DP4_180	X4Z1601794720			
20	Sklo 6,0x1879x497 10° čiré DS-SR-DV-017	2	1879x497mm - DP4_190	X4Z1601794970			
20	Sklo 6,0x1879x522 10° čiré DS-SR-DV-018	2	1879x522mm - DP4_200	X4Z1601795220			

21	Sklo 6,0x1824x215 10° čiré DS-SR-PS-010	2	1824x215mm - DP4_120	X4Z160I242150	
21	Sklo 6,0x1824x240 10° čiré DS-SR-PS-011	2	1824x240mm - DP4_130	X4Z160I242400	
21	Sklo 6,0x1824x265 10° čiré DS-SR-PS-012	2	1824x265mm - DP4_140	X4Z160I242650	
21	Sklo 6,0x1824x290 10° čiré DS-SR-PS-013	2	1824x290mm - DP4_150	X4Z160I242900	
21	Sklo 6,0x1824x315 10° čiré DS-SR-PS-014	2	1824x315mm - DP4_160	X4Z160I243150	
21	Sklo 6,0x1824x340 10° čiré DS-SR-PS-015	2	1824x340mm - DP4_170	X4Z160I243400	
21	Sklo 6,0x1824x365 10° čiré DS-SR-PS-016	2	1824x365mm - DP4_180	X4Z160I243650	
21	Sklo 6,0x1824x390 10° čiré DS-SR-PS-017	2	1824x390mm - DP4_190	X4Z160I243900	
21	Sklo 6,0x1824x415 10° čiré DS-SR-PS-018	2	1824x415mm - DP4_200	X4Z160I244150	
31	Madlo 10° vnější DS-ZA-004 zamak/chrom	2	315x37,7x28	X8DSZA004000A	
32	Podložka madla	8	Ø20x1	X3MA0100200	
33	Bužírka transparent prům. 5/7,5-5	4	Ø7,5x5	X80001075050	
34	Šroub madla	4	Ø12x30° M5	X3SM1800300	
35	Šroub M5x 6 DIN 914 stavěcí nerez	4	M5x6	X90914050060	
36	Madlo 10° vnitřní DS-ZA-003 zamak/chrom	2	315x38x28	X8DSZA003000A	
41	Krytka madla 10° Chrom	8	30,4x28,2x17	X3DSPL001A	
42	Podložka madla 10° AL Nosal transparent	4	203x22	X3DSPDL001	
43	Šroub M4x55 DIN 966 nerez A2	4	M4x55	X90966040550	
44	Madlo 10° vnější DS-AL-008-001	2	209x30x28	X3DSAL008001A	
45	Madlo 10° vnitřní DS-AL-008-002	2	209x30x28	X3DSAL008002A	

50	QL1120 Kolečko dveří Blix	4		X3BLQL112000	
55	HS-067 Kolečko Blix spodní	4		X3BLHS067000	
61	Magnet ILPEA C1246 dl.1879 mm	2	1879	X6C124600220	
62	Těsncí lišta Blix-10° dl.1900mm	2	1800	X8BLPL150050	
63	Těsncí lišta Blix-10° dl.1900mm	2	1879	X8BLPL150050	
64	Zasklívací profil 111 CB H 2652 Transparent	4	202/227/252/277/302/327 /352/377/402	X8B100000000	
65	Zasklívací profil 90 CB H 2586 Transparent	2	1830	X89000000000	
70	Šroub samořez 3,5x13 DIN 7981 A2 nerez	4	Ø3,5x13	X97981035130	
71	Šroub samořez 3,5x38 DIN 7981 A2 nerez	8	Ø3,5x38	X97981035380	
81	Podložka krytky šroubu	4	Ø10x4,5	X8BLPL157000	
82	Krytka šroubu Chrom	4	Ø11,4x5,1	X8BLPL15600A	
83	Šroub samořez 3,5x13 DIN 7981 A2 nerez	4	Ø3,5x13	X97981035130	
90	Koncovka 84A Chrom	2		X884A000000A	
91	Koncovka 84B Chrome	2		X884B000000A	

RAVAK a.s., Obecnická 285, 261 01 Příbram I, ČR
tel.: +420 318 427 111, fax: +420 318 427 278. e-mail: info@ravak.cz, web: www.ravak.cz

RAVAK SLOVAKIA spol. s r.o., Einsteinová 11, 851 01 Bratislava
tel.: +421 2 / 444 550 01, fax: +421 2 / 444 550 02, e-mail: obchod@ravak.sk, web: www.ravak.sk

RAVAK POLSKA S.A., Kałęczyn, ul. Radziejowicka 124, 05-825 Grodzisk Mazowiecki, POLSKA
tel.: 22 / 755 40 30, fax: 22 / 755 43 90, e-mail: info@ravak.pl, web: www.ravak.pl

RAVAK Hungary Kft., 1142 Budapest, Erzsébet királyné útja 125, HUNGARY
tel.: 06 (1) 223 13 15, 06 (1) 223 13 16, fax: 06 (1) 223 13 14, e-mail: info@ravak.hu, web: www.ravak.hu

Ravak Gesellschaft für Sanitärprodukte mbH, Alexanderstrasse 58, D - 45472 Mülheim an der Ruhr
Tel. (0208) 37789-30 Fax. (0208) 37789-55, e-mail: info@ravak.de, web: www.ravak.de

RAVAK a.s., Representative Office in Ukraine, 21 Dniprovska Naberezhna str., 2nd floor, 02081, Kyiv, Ukraine
tel.: 00380 44 2203232, 00380 44 3605200, fax: 00380 44 2204343, e-mail: ravak@ravak.kiev.ua, web: www.ravak.ua

OOO RAVAK ru. ul. Staropetrovskiy pr. 7A, Moskva 125 130,
tel./fax: 007 495 710 82 23, 007 495 450 12 77, e-mail: ravak@inbox.ru, web: www.ravak.com

RAVAK®

RAVAK a.s., Obecnická 285, 261 01 Příbram I
tel.: +420 318 427 200, +420 318 427 111 fax: +420 318 427 269
info@ravak.cz, www.ravak.com

Výrobce si vyhrazuje právo změny ceny, technických parametrů, či dalších skutečností
bez předchozího upozornění a nenese odpovědnost za tiskové chyby.